





-  **OVAL Manwaydoor inwards opening**
-  **Porte Ovale avec ouverture à l'intérieur**
-  **Ovale Mannlochtür, schwenkbar nach innen (Innenöffnung)**
-  **Puerta Oval de apertura interna**
-  **Portella Ovale apertura interna**



◆ 7029 458



STANDARD SIZE/* At temperature 50°C /122 °F

CODE	A	C	B	T	P.MAX
	mm	mm	mm	mm	bar
7029 458	446×311	6	80	3.0	1.5

IF YOU WANT TO CHECK FOR MORE DETAILS
PLEASE CHECK THE FOLLOWING DRAWING

*1BAR =14.5PSI=0.1MPA

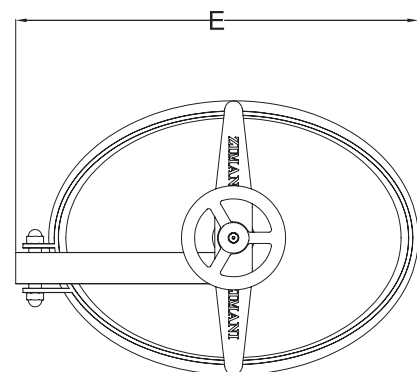
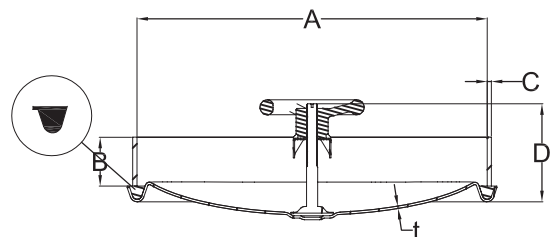

ZKE Parts Drawing

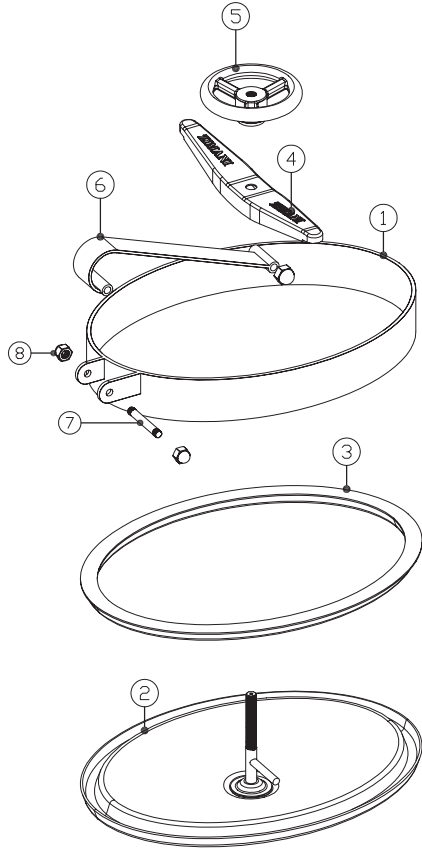

GASKET		
Part No.	Material	Color
7010-05 1	Silicon	White
7010-05 2	EPDM	Black
7010-05 3	FPM	Black

Item	Description	Material	Qty
1	Frame	1.4301/1.4404	1
2	Cover	1.4301/1.4404	1
3	Gasket	EPDM	1
4	Bracket	T304	1
5	Hand Wheel	Plastic/T304	1
6	Suspension arm	T304	1
7	Screw	T304	1
8	Nut	T304	3

ZKE Technology

TECHNICAL DATA

Working pressure: Acc. to table standard size.

Certificates

EN10204. 3.1 certificate

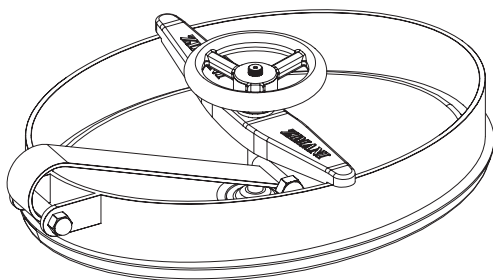

Options

Stainless Steel Finishes

POLISHED WITH RA (μ)

BEAD BLASTED

PICKLED : ON REQUEST

ELECTRO POLISHED

Cover & Frame Range

Cover Thickness	Frame/Neck Height
2.5mm	80mm (3.15")
3.0mm	100mm (3.94")
	120mm (4.72")
	150mm (5.91")
	200mm (7.76")

Note: Longer heights are also available.